

INNOVENS PRO MCA

WALL-HUNG GAS CONDENSING BOILERS

- MCA 45: from 8.9 to 43 kW for heating only
- MCA 65: from 13.3 to 65 kW for heating only
- MCA 90: from 15.8 to 89.5 kW for heating only
- MCA 115: from 18.4 to 114 kW for heating only



MCA 45, 65, 90 or 115



Cascade of MCA...



Heating and domestic hot water by independent calorifier



Condensing



All natural gases
Propane



EC identification No:
0063CL3333

INNOVENS PRO boilers can be delivered with the customer's choice of one of the following two control panels:

- **DIEMATIC iSystem** control panel to control and regulate up to 3 heating circuits + 1 DHW circuit, depending on optional equipment connected, according to the outside temperature. It can also be used to optimise management of combined control systems associated with boilers with iniControl (even DIEMATIC iSystem) and control cascades of 2 to 10 boilers (see page 16).

- **iniControl** for operation either according to outside temperature (sensor optional), or through the 0-10V contact fitted to this panel as standard. It can also be used as a secondary boiler as part of a cascade installation controlled by a boiler with the DIEMATIC iSystem control panel or in a cascade system in which each boiler is controlled in 0-10V (see page 19).

Various air/flue gas connection configurations are possible: we offer solutions for connection by horizontal or vertical forced flue, to a chimney or in twin pipe.

Complete hydraulic systems for connecting 2 to 10 boilers in cascade are also available; the 2- to 4-boiler versions are presented in this brochure.

CONDITIONS OF USE

Max. operating pressure: 4 bar
Max. operating temperature: 90°C
Safety thermostat: 110°C
Power supply: 230 V/50 Hz
Protection index: IPX4D

HOMOLOGATION

B_{23P} - C_{13x} - C_{33x} - C_{93x} - C₅₃

GAS CATEGORY

2_{ESi3P}, NO_x classification: 5

PRESENTATION

MCA 45 to 115 wall-hung condensing gas boilers offer a resolutely modern aesthetic in line with the INNOVENS range and a meticulous finish. With compact external dimensions (500 x 500 x 750 mm for all models) and less weight, MCA boilers are very simple to install and offer easy maintenance and accessibility.

THEY OFFER HIGH LEVELS OF PERFORMANCE

- Annual operating efficiency up to 110%
- Low pollutant emissions:
 - MCA 45: NO_x < 37 mg/kWh,
 - MCA 65: NO_x < 32 mg/kWh,
 - MCA 90: NO_x < 45 mg/kWh,
 - MCA 115: NO_x < 46 mg/kWh,
- NO_x classification:
 - 5 according to: - EN 483 (MCA 45, MCA 65)
 - pr EN 15420 (MCA 90, MCA 115)

STRONG POINTS



- **Compact, one-piece heating body in aluminium/silicium** alloy with a large exchange surface and low water resistance, offers considerable resistance to corrosion and requires only a very low irrigation flow rate (unless operating > 75°C) thanks to the burner control system, which manages the transitional phases in the installation which cause very low flow rates in the boiler. Its accessibility from the front facilitates maintenance,
- **Pre-mix burner in stainless steel** with surface in woven metal fibres, modulating from 18 to 100% of the output for perfect adaptation to needs, fitted with an air intake silencer. Low CO and NO_x emissions allowing optimal environmental protection,
- Gas line with non return valve,
Equipped to operate on natural gases and propane without conversion kit,
- INNOVENS PRO boilers can be delivered with the customer's choice of one of the two control panels:
 - **DIEMATIC iSystem:** control panel in which the control system is open to all installation configurations, including the most complex. As delivered, it can be used to control and regulate a direct circuit.

With the addition of a sensor, it can be used to regulate a primary circuit with mixing valve; with the addition of a PCB + sensor, it can control a secondary circuit with mixing valve. Installation of a DHW sensor enables regulation with priority to a DHW circuit. It is specifically designed to enable the optimisation of management of combined systems.

This control panel can also be used to control a cascade installation in which only the "master" boiler is fitted with this panel, the "slave" boiler(s) being fitted with an iniControl control panel. To connect more than the three circuits permitted to the master boiler, it is possible to insert one (or more) additional boilers with DIEMATIC iSystem control panel in the cascade

- **iniControl:** is used mainly in installations (whether in cascade or not) with external control cabinet for controlling all secondary circuits through the 0-10V contact fitted to this panel as standard. The panel can also be used alone to control a direct circuit + 1 DHW circuit through an outside temperature sensor (outside and DHW sensors available as options),
- **Numerous items of equipment** such as automatic air vent accessible from the outside, vent cylinder, flue gas discharge pipe in PPS, air/flue gas connection unit with measuring point, mains connection plug, inside lighting, connection cable for heating pump,
- Complete cascade hydraulic systems for two and up to ten boilers for installations ranging from 80 to 1070 kW (the 2- to 4-boiler versions are presented in this brochure: see page 12),
- **A variety of options** facilitating the implementation of these boilers as much as possible:
 - hydraulic connection kit include outlet/return valve, gas valve, safety valve, filling valve,
 - heating pump or primary pump, decoupling cylinder, condensate neutralisation tank, etc...
 - boiler BPB/BLC... tank with load pump
- **For the various air/flue gas connection options** (see page 15).

MODELS AVAILABLE

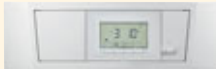
Boiler	Control panel	Model INNOVENS PRO	Power range (kW)	
			at 50/30 °C	at 80/60 °C
 <p>For heating only (possibility to connect a DHW tank through a connection kit with load pump - option)</p>		MCA 45 iSystem	8.9 to 43.0	8.0 to 40.0
		MCA 65 iSystem	13.3 to 65.0	12.0 to 61.0
		MCA 90 iSystem	15.8 to 89.5	14.1 to 84.2
		MCA 115 iSystem	18.4 to 114.0	16.6 to 107.0
		MCA 45 iniControl	8.9 to 43.0	8.0 to 40.0
		MCA 65 iniControl	13.3 to 65.0	12.0 to 61.0
MCA 90 iniControl		15.8 to 89.5	14.1 to 84.2	
MCA 115 iniControl		18.4 to 114.0	16.6 to 107.0	

TECHNICAL SPECIFICATIONS

DESCRIPTION

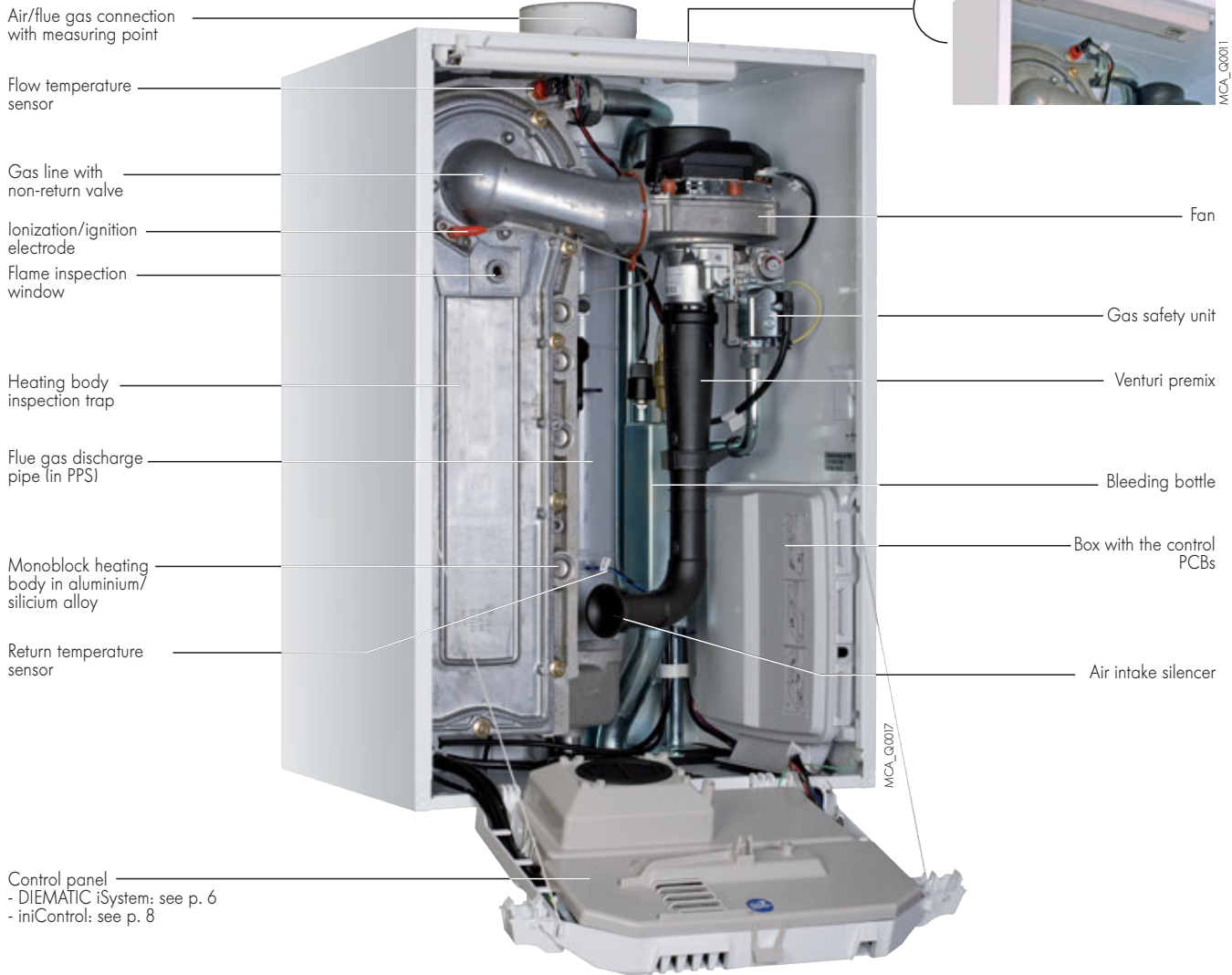

View of the underneath of the boiler



Detail heating body in aluminium/silicium alloy



TECHNICAL SPECIFICATIONS

TECHNICAL SPECIFICATIONS

Boiler

Type generator: heating only

Boiler type: condensing

Burner: modulating with complete premixing

Energy used: natural gas or propane

Combustion evacuation:

chimney or forced flue

Min. flow temperature: 20°C

Min. return temperature: 20°C

Ref. CE certificate: 0063CL3333

Boiler type		MCA	45	65	90	115
Useful output at 50/30°C Pn		kW	43	65	89.5	114
Efficiency	100% Pn at average temp. 70°C	%	97.2	98.3	97.9	96.6
	at ...% output					
	100% Pn at return temp. 30°C	%	102.9	104.6	104.1	102.5
	and ...°C water temp. 30% Pn at return temp. 30°C	%	107.7	108.9	108.1	107.1
Nominal water flow at Pn, Δt = 20 K		m ³ /h	1.72	2.62	3.62	4.60
Auxiliary electrical power at Pn/Pmin (without circul. pump)		W	68/18	88/23	125/20	199/45
Min./max. useful output at 50/30°C		kW	8.9-43	13.3-65.0	15.8-89.5	18.4-114
Min./max. useful output at 80/60°C		kW	8-40	12-61	14.1-84.2	16.6-107
Min./max. flue gas mass flow rate		kg/h	14/69	21/104	28/138	36/178
Pressure available at the boiler outlet		Pa	150	100	160	220
Water content		l	5.5	6.5	7.5	7.5
Min. necessary water flow (*)		m ³ /h	0.4	0.4	0.4	0.4
Water resistance at Δt = 20 K		mbar	90	130	140	250
Gas flow	natural gas H	m ³ /h	4.4	6.6	9.1	11.7
	propane	m ³ /h	1.7	2.5	3.5	4.7
Net weight		kg	53	60	68	69

(*) in the event of operating > 75°C, the minimum flow is calculated Δt = 45 K

MAIN DIMENSIONS (IN MM AND INCHES)

MCA 45, 65, 90, 115

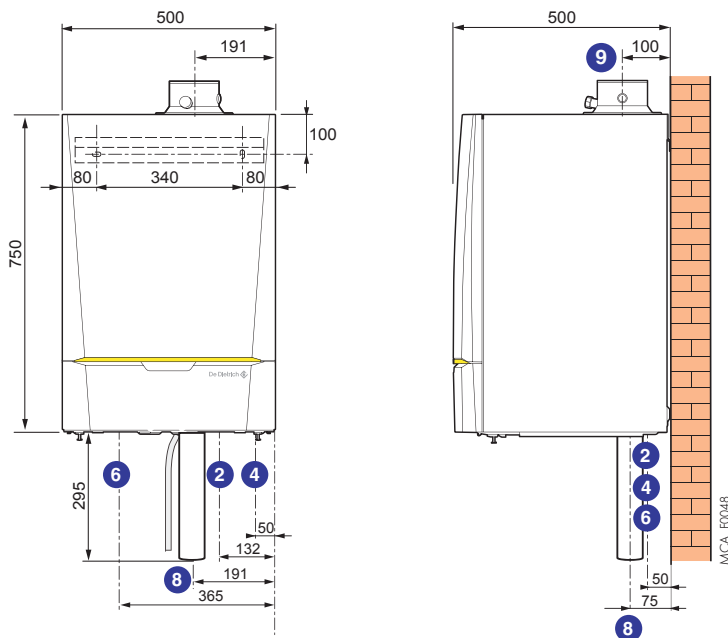

- ② Heating outlet R 1 1/4
- ④ Gas inlet R 3/4
- ⑥ Heating return R 1 1/4
- ⑧ Condensates drain (siphon and flexible drain, external Ø 25 mm, provided)

- ⑨ Evacuation of combustion products and air inlet pipe:
 - Ø 80/125 mm for MCA 45
 - Ø 100/150 mm for MCA 65, 90 and 115

CHOICE OF CONTROL PANEL

The control panel is chosen according to the installation to be constructed

INSTALLATION WITH A SINGLE BOILER

2 types of control panel are possible:





MCA...



iniControl

- for installations with control cabinet in 0-10 V in the boiler room
- for controlling a single direct circuit without hourly programming





Option:
outside sensor FM 46 



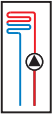
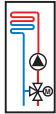
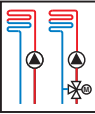
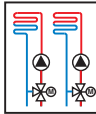
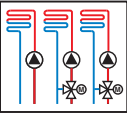

DIEMATIC iSystem

- for controlling a circuit:

 direct	 valve	 direct + 1 valve	 2 x valve	 direct + 2 x valve
Options: as standard	1 outlet sensor AD 199 	1 outlet sensor AD 199 	1 outlet sensor AD 199 + 1 PCB + sensor AD 249 	1 outlet sensor AD 199 + 1 PCB + sensor AD 249 

INSTALLATION WITH BOILERS IN CASCADE (2 TO 10 BOILERS)

With control panel iniControl:

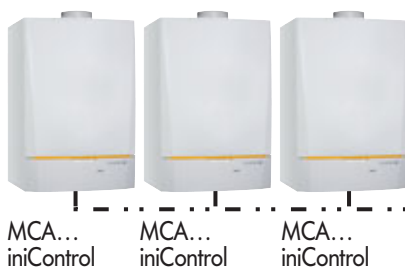

All of the boilers (as many as 10) will be connected using the 0-10 V contact to a control cabinet in the boiler room, which will manage all secondary circuits (see p. 19).

With DIEMATIC-iSystem control panel for the first boiler in the cascade (master boiler) and 1 iniControl panel for each of the slave boilers:







Boiler 1
MCA... iSystem
(master)



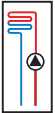
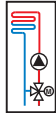
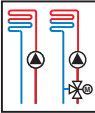
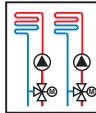
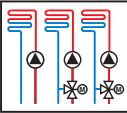

DIEMATIC iSystem

- for controlling a circuit:

 direct	 valve	 direct + 1 valve	 2 x valve	 direct + 2 x valve
Option: as standard	1 outlet sensor AD 199 	1 outlet sensor AD 199 	1 outlet sensor AD 199 + 1 PCB + sensor AD 249 	1 outlet sensor AD 199 + 1 PCB + sensor AD 249 

BUS





Boiler 1
MCA... iniControl
(slave)



iniControl

no additional secondary circuits can be connected to the iniControl panel (1)

(1) To connect more than three heating circuits to an installation in cascade, it will be necessary to replace one of the MCA... iniControl boilers in the cascade with one (or more depending on the number of additional circuits to be managed) MCA... iSystem boilers (see example of hydraulic diagram on page 18).



Boilers 2 to 10
MCA... iniControl
(slave)

DHW PRODUCTION

iniControl and DIEMATIC iSystem control panels include the priority of DHW production and can be completed with 1

DHW sensor-package AD 212 to control an independent calorifier.

5

CONTROL PANEL DIEMATIC iSystem

CONTROL PANEL DIEMATIC iSystem

The **DIEMATIC iSystem** control panel is a very advanced control panel, with new control ergonomics which includes electronic programmable regulation as standard to modulate the boiler temperature by activating the modulating burner according to the outside temperature and the room temperature if a CDI D. iSystem, CDR D. iSystem or simplified interactive remote control is connected (optional).

As standard, DIEMATIC iSystem is capable of automatically operating a central heating installation with a direct circuit without mixing valve and 1 circuit with mixing valve (the flow sensor - package AD 199 - must be ordered separately, however).

By connecting another "PCB + sensor for 1 valve circuit" option (package AD 249), it is therefore possible to control up to 3 circuits in total and each of these circuits can be fitted with a CDI or CDR D. iSystem remote control (optional).

Connection of a domestic hot water sensor makes it possible to programme and regulate a DHW circuit (package AD 212 - optional).

This control system has been specifically developed to enable **optimum management of systems combining various heating generators** (boiler + heat pump or + solar system...). It allows the installer to set the parameters for the entire heating installation regardless of its degree of complexity.

In the context of larger installations, it is also possible to connect 2 and as many as 10 boilers in cascade.

The DIEMATIC iSystem control panel will then be used as the master for the installation, the secondary boilers being fitted with the iniControl control panel. To connect more than the three circuits possible to the master boiler, make provision for a second (or further) boilers with DIEMATIC iSystem in the cascade.

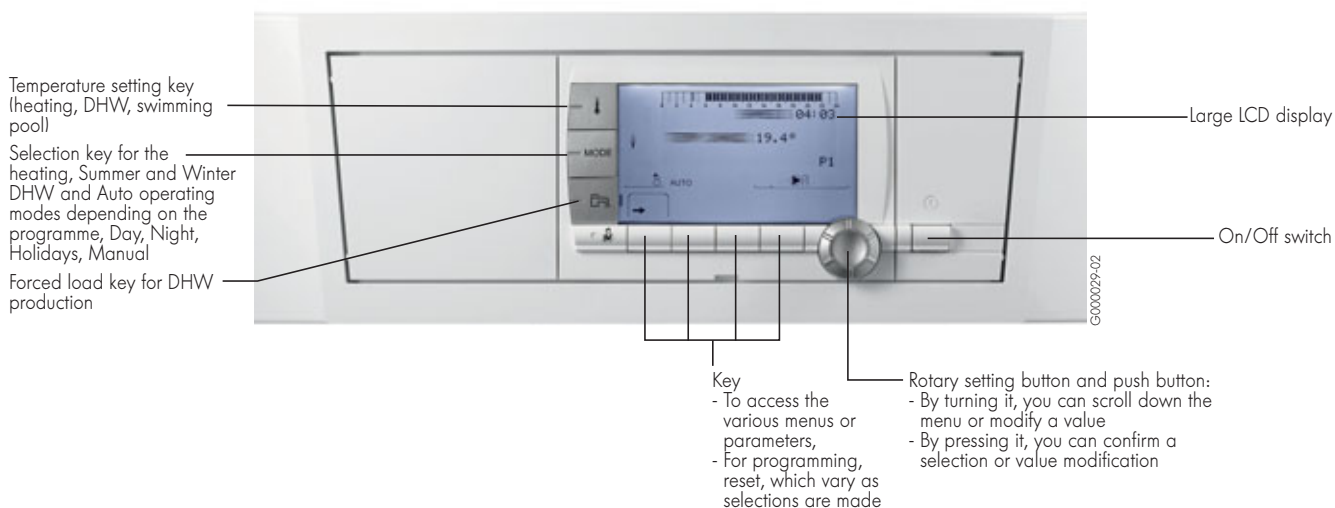

DIEMATIC iSystem CONTROL PANEL OPTIONS



Domestic hot water sensor - Package AD 212

This is used for regulating the DHW temperature as a priority and programming of domestic hot water production with an independent calorifier.



Outlet sensor downstream of the valve - Package AD 199

This sensor is required to connect the first circuit with mixing valve to a boiler fitted with a DIEMATIC iSystem control panel.



PCB + sensor for 1 mixing valve - Package AD 249

This is used to control a mixing valve with an electromechanical or electrothermal motor. The PCB is inserted into the DIEMATIC iSystem panel connected by pin connections. DIEMATIC iSystem

can receive 1 "PCB + sensor" option, enabling it to control 1 additional mixing valve.



Interface SCU - X03 in housing - Package HC 258

This box connects to the boiler (connecting cable supplied with the option) and can control a

modulating heating pump GRUNDFOS or WILO in 0-10 V.

CONTROL PANEL DIEMATIC iSystem

DIEMATIC iSystem CONTROL PANEL OPTIONS



CDI D. iSystem interactive remote control - Package AD 285

CDR D. iSystem interactive "radio" remote control (without transmitter/receiver radio) - Package AD 284
Radio boiler module DIEMATIC iSystem (transmitter/receiver) - Package AD 252

These are used to override all instructions from the DIEMATIC iSystem control panel from the room in which they are installed. In addition, they enable the self-adaptability of the heating regime for the circuit concerned (one CDI D. iSystem or CDR D. iSystem per circuit).

In the case of the CDR D. iSystem, the data are transmitted by radio waves from the place where the CDR D. iSystem is installed to the transmitter/receiver box (package AD 252) placed close to the boiler.



Simplified remote control with room sensor - Package FM 52

This is used from the room in which it is installed to override certain instructions from the DIEMATIC iSystem panel:

- room temperature program and instruction override. It is also used to enable the self-

adaptability of the heating curve for the circuit concerned (1 remote control per circuit).



Room sensor - Package AD 244

A room sensor is connected to activate the comfort period start-up optimisation function from the room in which it is installed. It is also used to enable the

self-adaptability of the heating curve for the circuit concerned (1 sensor per circuit).



BUS connection cable (length 12 m) - Package AD 134

The BUS cable is used to make the connection between 2 boilers fitted with the DIEMATIC iSystem or iniControl control panel in a cascade

installation, as well as the connection of a DIEMATIC VM iSystem control unit or a telemonitoring network transmitter.



Sensor for storage tank - Package AD 250

Includes 1 sensor for managing a storage tank with a boiler fitted with a DIEMATIC iSystem control panel.

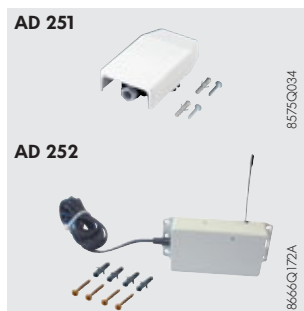

Radio outside temperature sensor - Package AD 251

Boiler radio module (radio transmitter) - Package AD 252

The radio outside temperature sensor can be delivered as optional equipment for systems in which the installation of the external wire connection sensor delivered with DIEMATIC iSystem control panel would be too complex.

If this sensor is used:

- With a wire connection remote control (AD 285 or FM 52), it is necessary to order the "boiler radio module"
- With a radio remote control (AD 284), already combined with a "boiler radio module" (AD 252), control of a second module is not necessary.



VM iSystem wall-hung control unit - Package AD 281

The VM iSystem electronic control system, incorporated in a wall-mounted box, is used to manage and control two heating circuits and a DHW circuit and each of the heating circuits may be a direct circuit or a circuit with motorised 3-way mixing valve.

It is possible to interlink up to 20 VM iSystem control systems and thus configure numerous combinations, regardless of the type of installation:

- VM iSystem can be used in combination with an existing generator to control additional heating and DHW circuits.
- VM iSystem can also be used fully autonomously on its own to control heating and DHW circuits

according to the outside temperature (sensor to be ordered separately – package FM 46) independently of the generator.

- VM iSystem can control a boiler via OpenTherm (existing outlet on VM iSystem) for a boiler equipped with an OpenTherm bus, or as «ON/OFF» via the auxiliary contact for any other generator (burner, HP, wood-fired boiler...).
- VM iSystem can control a cascade of boilers:
 - Equipped with a DIEMATIC control panel
 - Equipped with an OpenTherm BUS via an interface board (1 board per generator).

CONTROL PANEL iniControl

CONTROL PANEL iniControl

The iniControl control panel is used to manage a direct circuit and DHW production (without programming). Burner modulation according to the outside temperature is activated by connecting the outside temperature sensor (package FM46 – to be ordered separately).

The display of the boiler temperature, the pressure in the heating network, and the operating status of the generator using symbols and alphanumeric codes is handled by the large display, which also incorporates a flashing alarm function.

To monitor the installation, optional readout of error history and hour run meters. The iniControl control panel also enables boiler management through a parameterisable 0-10V signal. In the case of a cascade installation, the iniControl panel will be fitted to the secondary boilers linked in series to the master boiler fitted with the iSystem control panel using the BUS cable (optional).

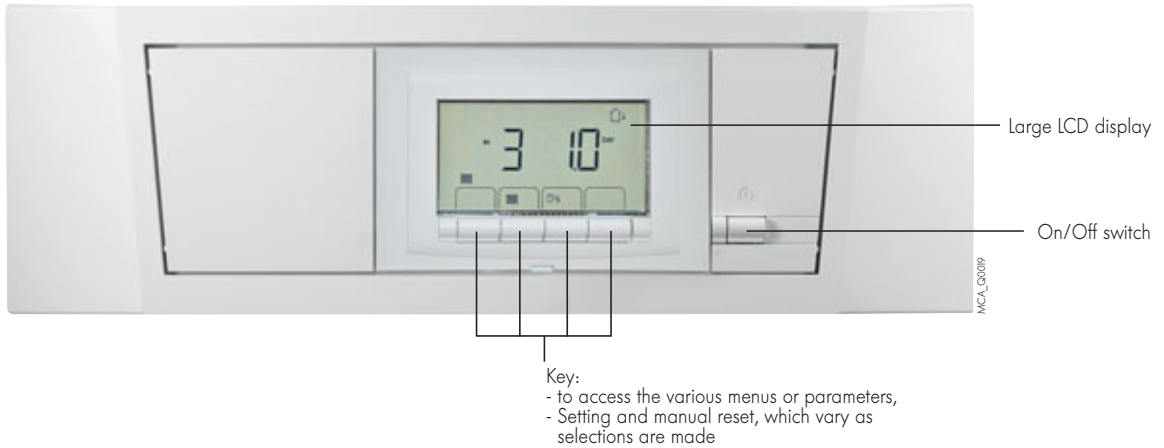

iniControl CONTROL PANEL OPTIONS



Outside sensor - Package FM 46
 Allows the management of the circuit heating by measuring of the outside temperature.



Domestic hot water sensor - Package AD 212
 This is used for regulating the DHW temperature as a priority and programming of domestic hot water production with an independent calorifier.

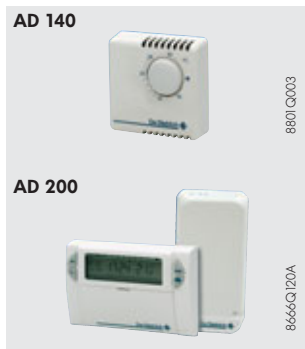

Programmable room thermostat (wire) - Package AD 137
Programmable room thermostat (wireless) - Package AD 200
Non-programmable room thermostat - Package AD 140

These thermostats handle the regulation and weekly programming of the heating by activating the burner and in accordance with the following 3 modes of operation:
AUTOMATIC: according (4 programs to choose from) automatically commutes the installation into «comfort» or «low» mode. The comfort and low temperatures can be adjusted between 5 and 30°C.

PERMANENT: maintains the set temperature all the time (between 5 and 30°C).
VACATION: intended for absences of long duration, maintains the desired temperature (between 5 and 30°C) for a predetermined duration (1 to 99 days).

BOILERS OPTIONS



Hydraulic connection kit + gas valve - Package HC 139

This kit includes:

- 1 gas valve Rp 3/4
- 1 heating flow valve Rp 1 1/4 including the filling and draining valve

- 1 heating return valve Rp 1 1/4 with safety valve 3 bar and connection for connecting the expansion vessel

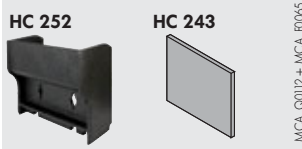

Insulation for boiler hydraulic connection kit - Package HC 252 Rear insulation for boiler hydraulic connection kit - Package HC 243*

Are used to insulate the HC139 pack available as optional equipment.

* only possible with LV or RG cascade configuration



Right gas tap Rp 3/4 - Package HC 158

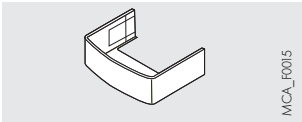

Pipe cover - Package HC 242

Provides a neat finish underneath the boiler. This package is not compatible with the connection kit HC 139.

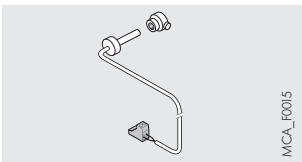

Flue gas thermostat - Package HR 43

This thermostat cuts the boiler when the flue gas temperature exceeds 110°C.



3-stage heating pump - MCA 45 - Package HC 141 - MCA 65 - Package HC 143 - MCA 90 and MCA 115 - Package HC 145

(delivered with 2 joins "1/2 union" 1"1/2-1")

Specifications of the pump UPS 25-60 130

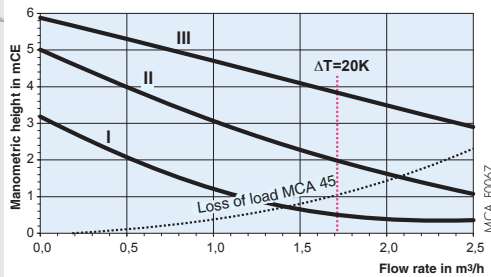

Specifications of the pump UPS 25-70 130

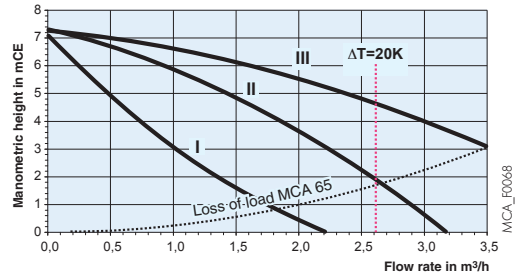

Specifications of the pump UPS 25-80 130

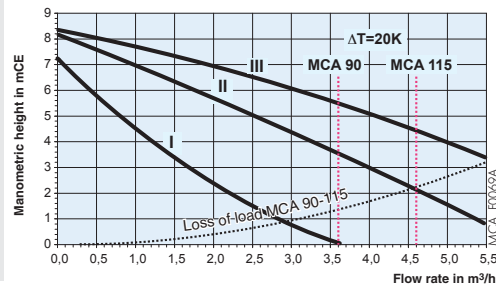

BOILERS OPTIONS



Modulating electronic heating pump of class A (high performance energy) for MCA 45 - Package HC 142
(delivered with 2 gaskets "1/2 union" 1"1/2-1")

Specifications of the pump ALPHA 2 L 25-60 130

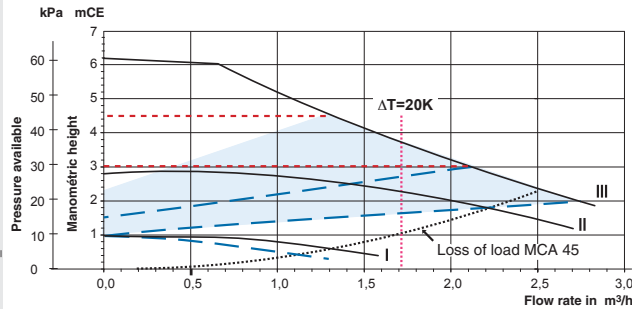

--- Constant pressure
 - - - Proportional pressure
 — Pump on "AutoAdapt" position

MCA_F0066C



Primary pump for MCA 45, 65, 90 and 115 - Package HC 147
(delivered with 2 gaskets "1/2 union" 1"1/2-1")

This pump can be used as injection pump in the cascade systems.

Specifications of the pump UPS 25-55 180

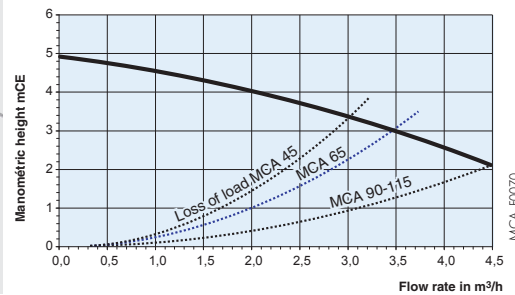

MCA_F0070



Motorized 3 way valve (Rp 1) - Package HC 15

Allows the connection of a circuit with mixing valve.

8531G020

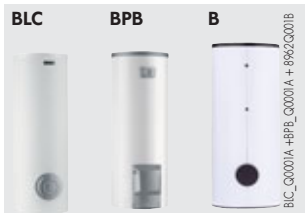

DHW production

De Dietrich B... series independent DHW tanks with a capacity of 150 to 1000 litres can be used for domestic hot water production for individual and collective residences as well as for industrial and commercial premises. They are lined with food quality standard high quartz content vitrified

enamel and protected by a magnesium anode for BPB/BLC... and B 650, and "correx" imposed current for B 800 and 1000. The specifications and performances of these tanks are given in the product catalogue and the technical leaflets.

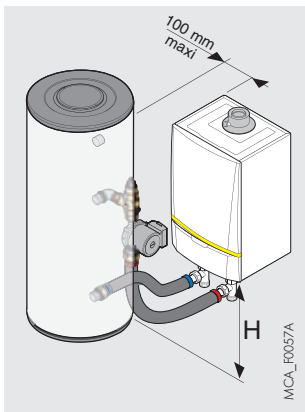

MCA 45, 65, 90 and 115 / BPB/BLC..., BSL or TRIO calorifiers connecting kit - Package EA 121

In addition to the load pump, a non-return valve, a manual air vent, this pack also includes stainless steel connection hoses... which enable the connection of an MCA boiler to a DHW tank type BPB/BLC..., or solar BSL or TRIO... to the right or left of the boiler.

	BPB/BLC...	BSL, TRIO
H mini	1080 maxi	800 mini

BOILERS OPTIONS

GV 45/ GV 46



MCA_Q0038

60/60 - 1" decoupling cylinder for MCA 45 and MCA 65 - Package GV 45
80/80 - 1" 1/4 decoupling cylinder MCA 90 and MCA 115 - Package GV 46

For all installations with 2 circuits (1 direct circuit + 1 valve circuit) or for installations in cascade, the use of a decoupling cylinder is highly recommended.

The decoupling cylinder are delivered insulated and fitted with a bracket to secure it to the wall.

HC 33



8531_Q027

Condensate neutralisation tank boilers up to 70 kW - Package HC 33

or

Condensates neutralisation system with the pump:

- boilers or cascade of boilers up to 120 kW - Package DU 13
- boilers or cascade of boilers from 120 to 350 kW - Package DU 14
- boilers or cascade of boilers above 350 kW - Package DU 15

DU 13, 14 or 15



C210_Q0014

The materials used for the condensates flow pipes must be appropriate; otherwise the condensates must be neutralised.

Principle: The acidic condensates flow through a tank filled with granules before being discharged into the waste water network.

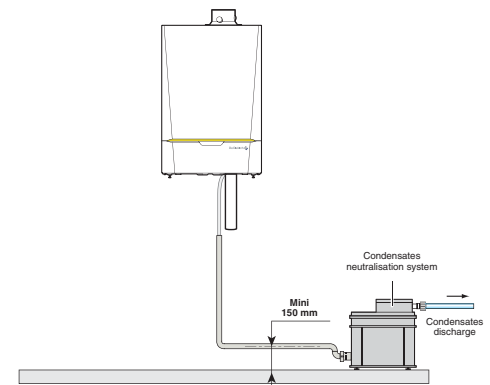

MCA_F0035

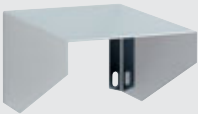

8531_Q028A

Wall bracket for neutralisation tank HC 33 - Package HC 34

This support allows secure the neutralisation tank HC 33 to the wall.

Granule refill for neutralisation tank HC 33 - Package HC 35 (2 kg)

Granule refill for neutralisation station DU 13, DU 14 and DU 15 - Ref. 9422-5601 (10 kg)

An annual check of the neutralisation system, particularly the effectiveness of the granules, by

measuring the pH is necessary. If need be, the granules must be replaced.



C210_Q0016

Cleaning tool boiler body for MCA 45 and MCA 65 - Package HC 246
Cleaning tool boiler body for MCA 90 and MCA 115 - Package HC 247

Allows the cleaning of the heating body accessible by the inspection hatch.

STOVE FITTING ACCESSORIES SPECIFIC TO BOILERS INNOVENS PRO

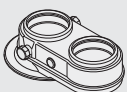

MCA_F0015

Twin pipe adapter Ø 80/125 mm to 2 x 80 mm - Package DY 906

Twin pipe adapter Ø 100/150 mm to 2 x 100 mm - Package DY 907

CASCADE SYSTEMS

CASCADE SYSTEMS OPTIONS



Gas filter - Ø 50 mm for cascade systems from 80 to 428 kW - Package HC 255
 - Ø 65 mm for cascade systems from 428 to 1 070 kW - Package HC 256



Extension pipe for gas filter - Ø 50 mm for cascade systems from 80 to 428 kW - Package HC 211
 - Ø 65 mm for cascade systems from 428 to 1070 kW - Package HC 212

To use if the gas filter is mounted on the same side as:
 - the decoupling cylinder + elbows set (options: see below),
 - the decoupling cylinder + his insulation (options: see below).



Set of elbows 90° - Ø 65 mm for cascade systems from 80 to 428 kW - Package HC 209
 - Ø 100 mm for cascade systems from 428 to 1 070 kW - Package HC 210

Delivered with gaskets, nuts and bolts enabling connection of the decoupling cylinder perpendicular to the collector.



Set of counter flanges to be welded - Ø 65 mm for cascade systems from 80 to 428 kW - Package HC 217
 - Ø 100 mm for cascade systems from 428 to 1 070 kW - Package HC 218

Contains 3 counter flanges: 2 for the installation side of the pressure reduction vessel (Ø 65 mm or 100 mm) and 1 for the gas pipe (Ø 50 mm or 65 mm).
 Delivered with gaskets, nuts and bolts.



Decoupling cylinder insulation - small model for power < 350 kW - Package HC 224
 - large model for power > 350 kW - Package HC 215

Suitable for vessels with connection Ø 65 or Ø 100 mm.



Collector insulation - Package HC 213
 It's necessary to order 1 kit insulation by boiler.

Nota: in a "back to back" installation, to be ordered only for the boilers located at the front.

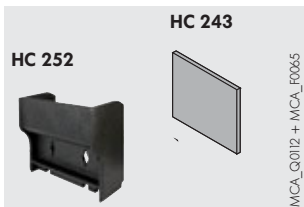

Boiler connection insulation kit - Package HC 252

Insulation using a boiler connection pack is necessary.

Rear insulation of the hydraulic connection pack - Package HC 243

Used to insulate the rear of the pack, insulation using a pack is necessary.



Insulation 90° elbow - Package HC 216
 Suitable for Ø 65 and Ø 100 mm elbows.



Adjustable foot - Package HC 219
 Is used for linear "LV" or back to back "RG" installations if the floor is uneven.

Alignment	on-line, on the floor "LV"						back to back "RG"							
Number of boilers	2	3	4	5	6	7	3	4	5	6	7	8	9	10
Number of necessary feet	5	6	8	9	11	12	7	7	8	8	11	11	12	12

INSTALLATION OF AN MCA BOILER ON AN "LV" OR "RG" CASCADE SYSTEM COMPOSED OF EXISTING MC BOILERS

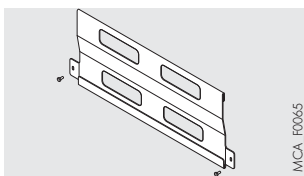

MCA mounting rail on an MC cascade system - Package HC 245

This rail is hooked on to the base frame of the existing cascade system ("LV" floor alignment or "RG" back to back only) and is used to align the base of the new MCA boiler with the other boilers in the cascade and to make the hydraulic connection without modifying the existing pack.

INFORMATIONS REQUIRED FOR INSTALLATION

STATUTORY INSTRUCTIONS ON INSTALLATION AND MAINTENANCE

The installation and maintenance of the appliance in both residential buildings and establishments open to the public must

be carried out by a qualified professional in compliance with the statutory texts of the codes of practice in force.

LOCATION

MCA 45 and 65:

MCA 45 and 65 condensing boilers must be installed in premises protected from frost, which can also be ventilated, they must in no event be installed above a heat source or a cooking appliance. The IPX4D protection index enables them to be installed in kitchens and bathrooms, excluding protection volumes 1 and 2, however. The wall to which the boiler is secured must be capable of bearing the weight of the boiler when full of water. In order to ensure adequate accessibility around the boiler, we recommend that you respect the minimum dimensions given opposite.

Ventilation (chimney connection only B_{23P}):

The cross-section of the boiler room ventilation (through which combustive air is taken in) must comply with the prevailing standard.

NB: For boilers connected to a concentric forced flue (type C_{13x} or C_{33x} connections) ventilation of the installation premises is not necessary, unless the gas supply includes one or more mechanical connections (cf. prevailing standard).

MCA 90 and 115:

As for the MCA 90 and 115 boilers, they will be installed in accordance with the rules on installation in mini-boiler rooms outside the residential space, in a dedicated room. The rules on installation of (horizontal or vertical) terminals should also be respected - see page 16.

MCA 45 and 65:

S1 and S2:

free sections of:

- 600 cm² (in connect. B_{23P})
- 150 cm² (in connect. C_{13x}, C_{33x}, C_{93x}, C₅₃)

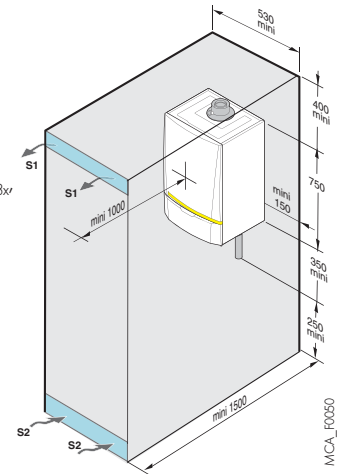

Ventilation:

Direct air inlet according to the prevailing standard

Top and bottom ventilation vents mandatory

- Top ventilation:

Cross section equal to half of the total cross section of the flue gas conduits with a minimum of 2.5 dm²

- Bottom ventilation:

Direct air inlet

$$S \text{ (dm}^2\text{)} \geq \frac{0.86 P}{20} \text{ with } P = \text{Installed output in kW}$$

The location of air inlets in relation to the top ventilation openings will ensure that air is renewed in the entire volume of the boiler room. See also recommendations in the "Flue Systems" booklet.



In order to avoid damage to boilers, it is necessary to prevent the contamination of combustion air by chloride and/or fluoride compounds, which are particularly corrosive.

These compounds are present, for example, in aerosol spray cans, paints, solvents, cleaning products, washing powders/liquids, detergents, glues, snow clearing salts, etc.

It is therefore necessary:

- To avoid sucking in air discharged from premises using such products: hairdressers, dry cleaners, industrial premises (solvents), premises containing refrigeration systems (risk of leaking refrigeration fluid), etc.
- To avoid the storage of such products close to boilers.

Please note that, if the boiler and/or its peripherals become corroded by chloride and/or fluoride compounds, our contractual warranty cannot be invoked.

GAS CONNECTION

Compliance with prevailing instructions and regulations is mandatory. In all cases, a sectional valve is fitted as close as possible to the boiler. This valve is delivered in the hydraulic connection kits available as optional equipment (see p. 9). A gas filter must be fitted to the boiler inlet.

The diameters of the pipes must be defined according to the prevailing regulations.

Gas supply pressure:

- 20 mbar on natural gas H,
- 37 mbar on propane.

Certificate of conformity

The installer is required to draw up a certificate of conformity approved by the ministers responsible for construction and gas safety.

ELECTRICAL CONNECTION

This must comply with the prevailing national or even local instructions and regulations.

The boiler must be powered by an electrical circuit comprising an omnipolar switch with an opening gap > 3 mm. Protect the connection to the mains with a 6A fuse.

Note:

- The sensor cables must be separated from the 230 V circuits by at least 10 cm
- In order to protect the pump antifreeze and cleaning functions, we recommend not switching off the boiler at the mains switch.

INFORMATIONS REQUIRED FOR INSTALLATION

AIR/FLUE GAS CONNECTION

For the use of the air/flue gas connection pipes and the rules on installation, see details of the various configurations in the current product catalogue.

Classification

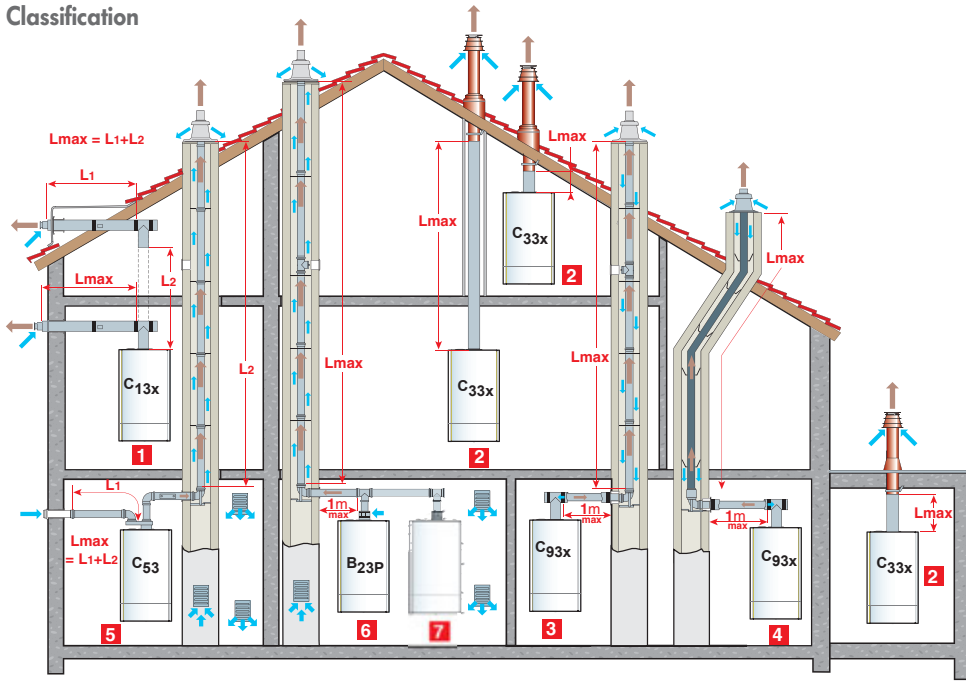

- 1 **Configuration C_{13x}**: Air/flue gas connection by means of concentric pipes to a horizontal terminal (so-called forced flue)
- 2 **Configuration C_{33x}**: Air/flue gas connection by means of concentric pipes to a vertical terminal (roof outlet) or
- 3 **Configuration C_{93x}**, (formerly C_{33x}): Air/flue gas connection using concentric pipes in the boiler room and single pipes in the chimney (combustive air with counter current in the chimney) or
- 4 **Configuration C_{93x}**: Air/flue gas connection using concentric pipes in the boiler room and single "flex" pipes in the chimney (combustive air with counter current in the chimney)
- 5 **Configuration C₅₃**: Separate air and flue gas connection using a twin pipe adapter and single pipes (combustive air taken from outside)
- 6 **Configuration B_{23P}**: Connection to a chimney (combustive air taken from the boiler room)
- 7 **Configuration B_{23P}**: For cascade installation

Table of maximum air/flue gas pipe lengths admissible according to boiler type

Type of air/flue gas connection		L _{max} of the connecting pipes in m				
		MCA 45	MCA 65	MCA 90	MCA 115	
Concentric pipes connected to a horizontal terminal (PPS)	C _{13x}	Ø 80/125 mm	16	-	-	-
		Ø 110/150 mm	-	9	8	5.9
Concentric pipes connected to a vertical terminal (PPS)	C _{33x}	Ø 80/125 mm	14.5	-	-	-
		Ø 110/150 mm	-	11.5	10	9.4
Pipes - concentric in the boiler room, - single in the chimney (combustive air with counter current) (PPS)	C _{93x}	Ø 80/125 mm	15	-	-	-
		Ø 80 mm	25	-	-	-
		Ø 100 mm	-	16	13.2	10
		Ø 110/150 mm Ø 110 mm	-	16	13.2	10
Pipes - concentric in the boiler room, - "flex" in the chimney (combustive air with counter current) (PPS)	C _{93x}	Ø 80/125 mm	12	-	-	-
		Ø 80 mm	-	16.5	13.5	9.4
		Ø 110/150 mm	-	16.5	13.5	9.4
		Ø 110 mm	-	16.5	13.5	9.4
Twin pipe adapter and separate single air/flue gas pipes (combustive air taken from outside) (Alu)	C ₅₃	Ø 80/125 mm to 2x80 mm	20.5	-	-	-
		Ø 100/150 mm to 2x100 mm	-	23	17.5	16
In the chimney (rigid or flex) (combustive air taken from the premises) (PPS)	B _{23P}	Ø 80 mm (rigid)	23.5	-	-	-
		Ø 80 mm (flex)	21	-	-	-
		Ø 110 mm (rigid)	-	40	40	40
		Ø 110 mm (flex)	-	29.5 (I)	24	17.5

(I) Δ : Max. height in the flue pipe (C_{93x} and B_{23P} configurations) from the support elbow to the outlet mustn't exceed:

- 30 m for rigid PPS

- 25 m for flex PPS

In case of higher lengths, holding collars must be added by slices of 25 or 30 m.

Important:

We remind you on the next page of the rule on installation of terminals on sealed appliances (type C) with a total output ≥ 70 kW installed in a boiler room, which use gas fuels.

EXAMPLES OF INSTALLATIONS

EXAMPLES OF INSTALLATION

The examples presented below cannot cover the full range of installation scenarios which may be encountered. Their purpose is to draw the attention to the basic rules to be followed. A certain number of control and safety devices (some of which are already integrated as standard in MCA boilers) are represented but it is ultimately up to installers, experts, consultant engineers and design departments to take the final decision on the safety and control devices to be used in the boiler room according to its specificities. In all cases, it is necessary to abide by the codes of practice and prevailing regulations.

according to its specificities. In all cases, it is necessary to abide by the codes of practice and prevailing regulations.

Attention: For the connection of domestic hot water, a sleeve made of steel, cast iron or any other insulating material must be interposed between the hot water outlet and these pipes to prevent any corrosion to the connections, if the distribution pipes are made of copper.

DIEMATIC iSystem CONTROL PANEL

Installation of a MCA 45 with 1 direct circuit + 1 BPB/BLC... DHW calorifier

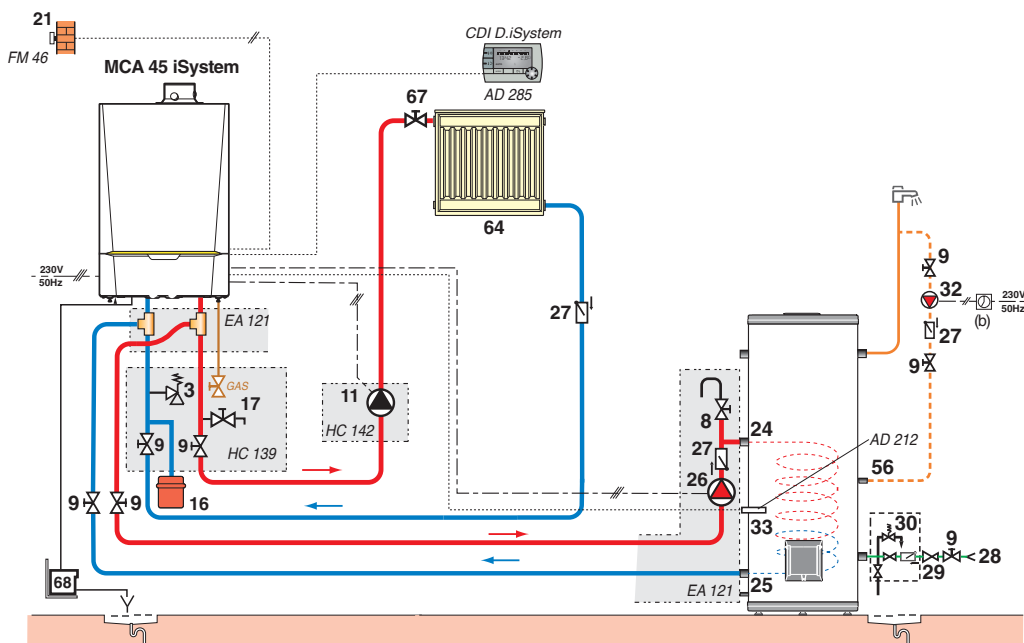

MCA_F0051D

Installation of a MCA 65 with 1 direct circuit + 2 circuits with mixing valve + 1 BPB/BLC... DHW calorifier, all behind a decoupling cylinder

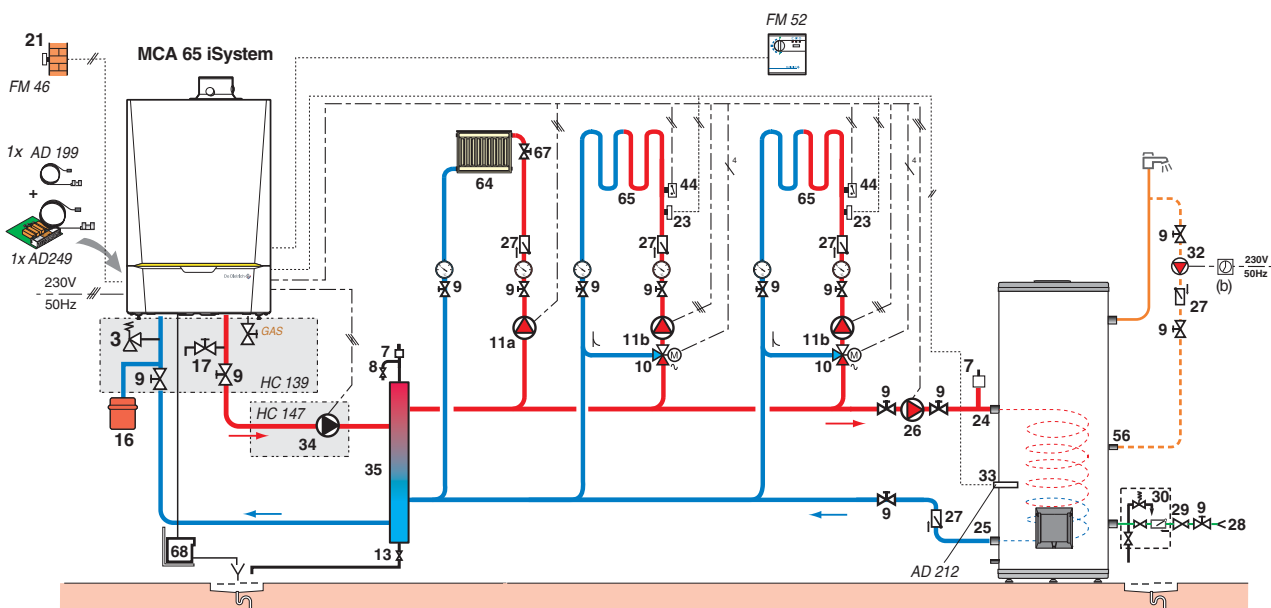

MCA_F0053B

Legend: see page 18

EXAMPLES OF INSTALLATIONS

Installation of a MCA 45 iSystem with 1 radiators circuit + 1 circuit with mixing valve + 1 solar system DIETRISOL for DHW production, all behind the decoupling cylinder

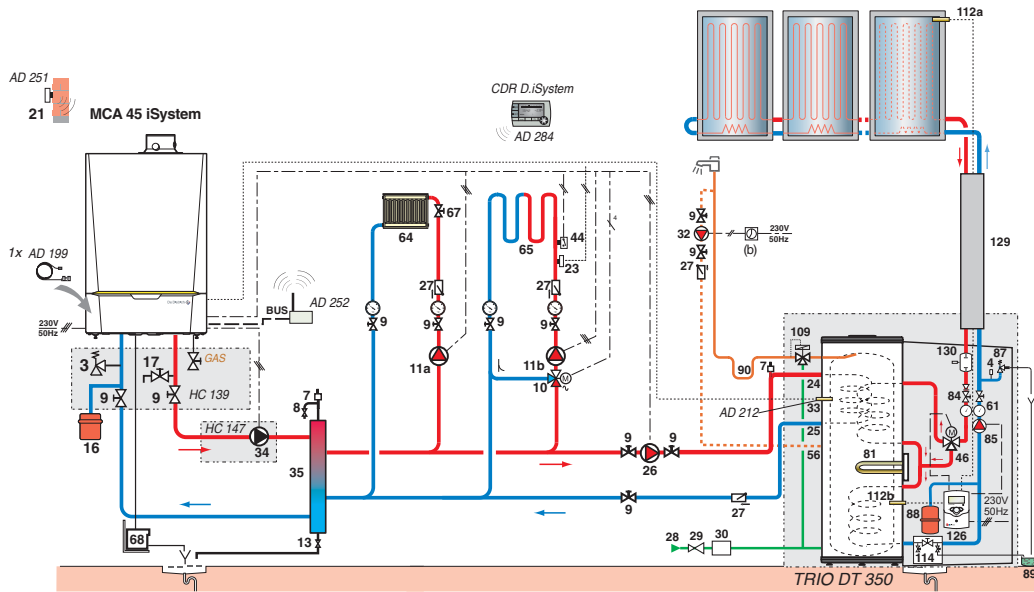

iniControl CONTROL PANEL

Installation of a MCA 45 iniControl with 1 direct circuit + 1 BPB/BLC... DHW calorifier

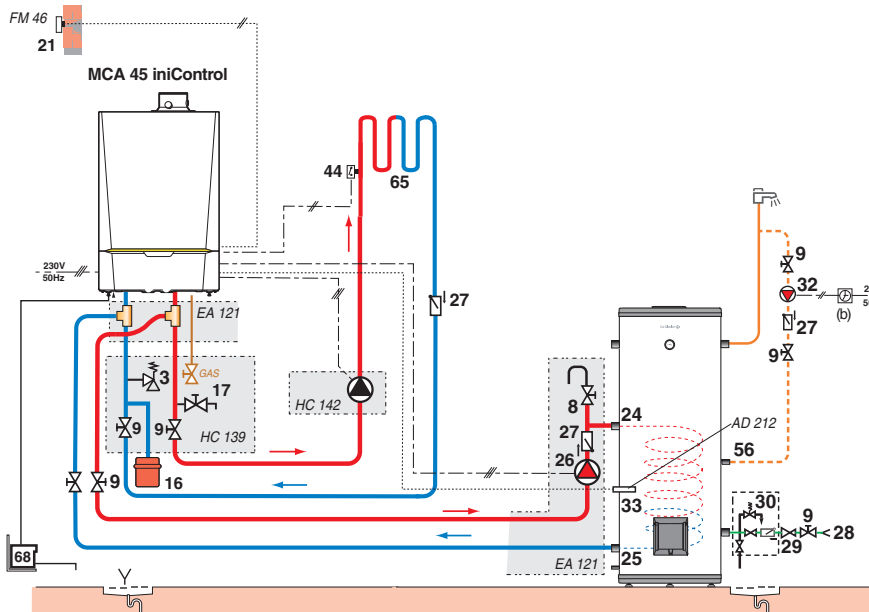

Legend

- | | | | |
|---|---|--|--|
| 1 Heating outlet | 24 Primary inlet on the DHW tank exchanger | 46 3 way-directional valve with motor reversing | 87 Safety valve sealed and calibrated to 6 bar |
| 2 Heating return | 25 Primary outlet on the DHW tank exchanger | 56 DHW circulation loop return | 88 Solar expansion tank 18 l |
| 3 Safety valve 3 bar | 26 Domestic water load pump | 61 Thermometer | 89 Receptier for heat transfer fluid |
| 4 Pressure gauge | 27 Non-return valve | 64 Radiator circuit (gentle heat radiators, for example) | 90 Antithermosiphon loop (≈ 10 x Ø tube) |
| 7 Automatic air vent | 28 Domestic cold water inlet | 65 Low temperature circuit (underfloor heating, for example) | 109 Thermostatic mixing valve |
| 8 Manual air vent | 29 Pressure reducer | 67 Manual valve | 112a Collector sensor |
| 9 Isolation valve | 30 Sealed safety device calibrated to 7 bars | 68 Condensates neutralisation system | 112b Solar tank sensor |
| 10 3-way mixing valve | 32 (Optional) DHW loop pump | 79 Primary outlet of the solar exchanger | 114 Solar circuit drainage valve (note: propyleneglycol) |
| 11 Electronic heating pump | 33 DHW temperature sensor | 80 Primary inlet of solar exchanger | 123 Cascade flow sensor (to connect to the slave boiler) |
| 11a Electronic heating pump for direct circuit | 34 Primary pump | 81 Electrical resistance | 126 Solar regulator |
| 11b Electronic heating pump for circuit with mixing valve | 35 Decoupling cylinder (available as an option - see page 11) | 84 Stop valve with releas non return valve | 129 DUO tube |
| 13 Flush valve | 39 Injection pump | 85 Solar circuit pump (to connect to the solar control) | 130 Degasser with manual purge (Airstop) |
| 16 Expansion tank | 44 65°C limiter thermostat with manual reset for underfloor heating | | (b) outside clock |
| 17 Draining valve | | | |
| 21 Outside sensor | | | |
| 23 Outlet temperature sensor after mixing valve | | | |

MCA_F0054C

MCA_F0058D

EXAMPLES OF INSTALLATIONS

EXAMPLES OF INSTALLATIONS IN CASCADE

Installation of 3 boilers: 1 MCA... iSystem boiler and 2 MCA... iniControl boilers in cascade with 1 direct circuit + 2 circuits with mixing valve and DHW circuit

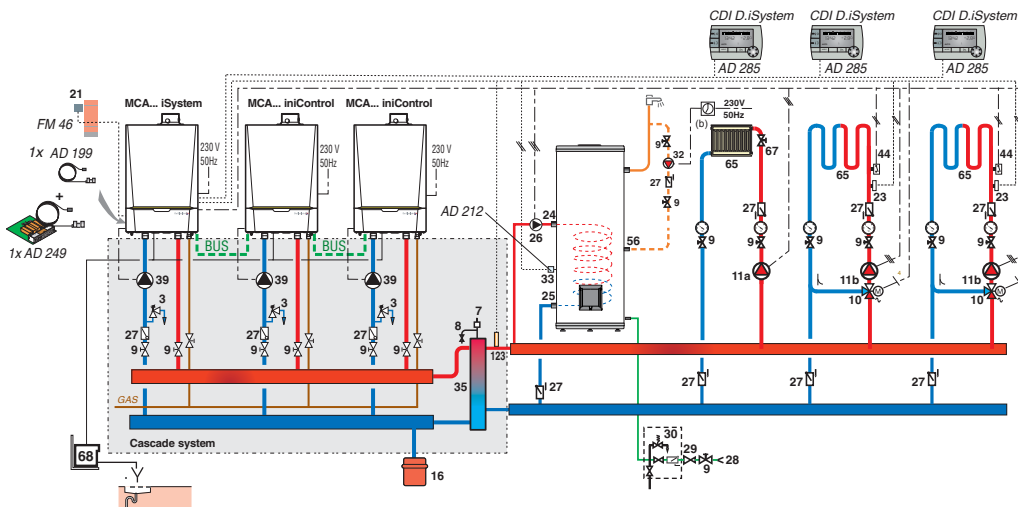

MCA_F0056B

Particular case of a cascade system with more than 2 secondary circuits with mixing valve:

Installation of 4 boilers: 2 MCA... iSystem boilers and 2 MCA... iniControl boilers in cascade with 4 circuits with mixing valve

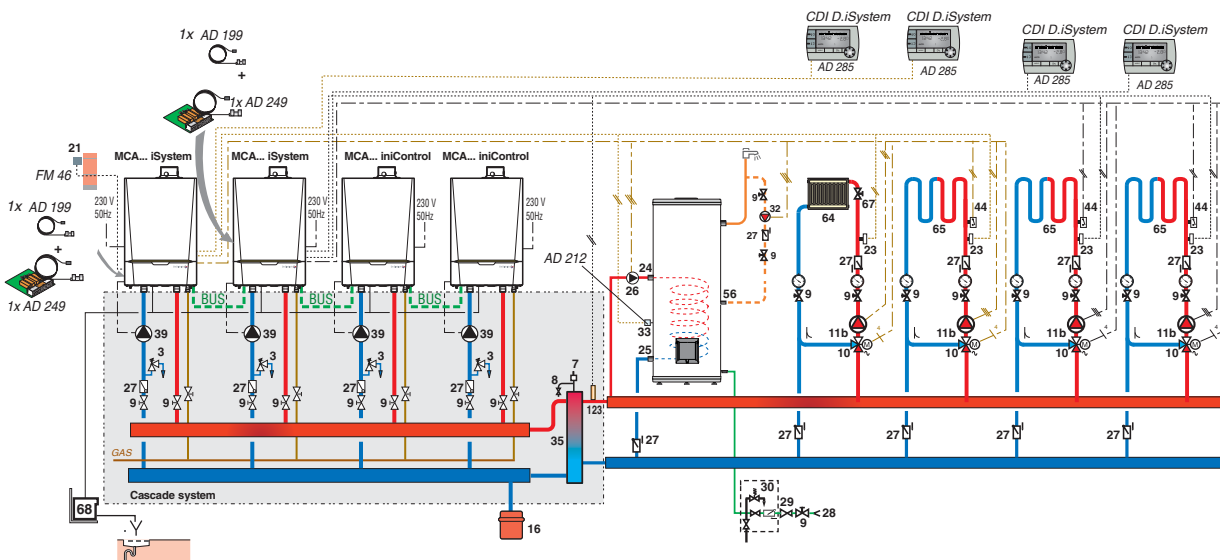

MCA_F0059C

Installation of MCA... iniControl boilers in cascade

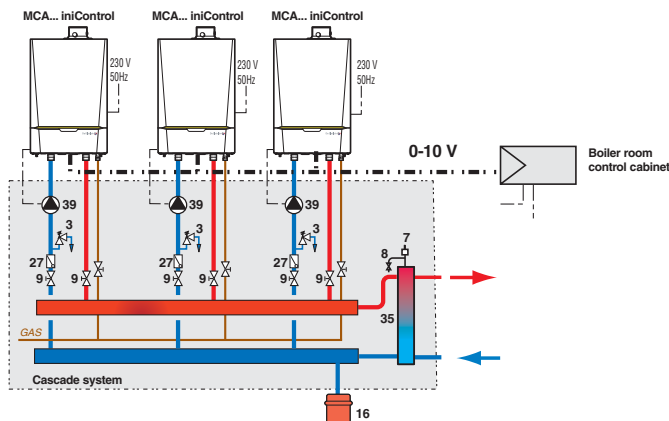

MCA_F0059A

NB: In the case of a cascade installation using only MCA... iniControl boilers, the BUS cables and the cascade flow sensor delivered with the system are not used.

Legend: see page 18

DESCRIPTION

INNOVENS PRO MCA...

WALL-HUNG GAS CONDENSING BOILER FOR CONNECTION TO A CHIMNEY OR A FORCED FLUE

Brand: De Dietrich

Classification: ★★★★★ according to the european efficiency directive,
NOx classification: 5

Model:

MCA... for heating only

Homologation: B_{23P}-C_{13x}-C_{33x}-C_{93x}-C₅₃

Protection index: IPX4D

Power supply: 230 V/50 Hz

Useful output in heating mode at 50/30°C: _____ kW

Max. operating temperature: 90°C

Max. operating pressure: 4 bar

Safety thermostat: 110°C

Dimensions: 750 x 500 x 500 mm

Weight empty: _____ kg

DESCRIPTON

Complies with the requirements of European Directives

- Compact monobloc heating body in aluminium/silicium alloy
- Gas premix burner in stainless steel with a surface in woven metallic fibres, modulating from 18 to 100% output, fitted with a silencer on the air intake
- Gas line with non return valve
- Cascade up to 10 boilers
- **DIEMATIC iSystem** control panel to control and regulate up to 3 heating circuits + 1 DHW circuit, depending on optional equipment connected, according to the outside temperature. It can also be used to optimise management of combined control systems associated with boilers iniControl (even DIEMATIC iSystem) and control cascades of 2 to 10 boilers.
- **iniControl**: for operation either according to the outside temperature (sensor optional), or through the 0-10V contact fitted to this panel as standard. It can also be used as a slave boiler as part of a cascade installation controlled by a boiler with the iSystem control panel or in a cascade system in which each boiler is controlled in 0-10V.

DIEMATIC iSystem control panel options

- Domestic hot water sensor
- Outlet sensor downstream of the valve
- PCB + sensor with mixing valve
- CDI D. iSystem interactive remote control
- CDR D. iSystem interactive "radio" remote control (without transmitter / receiver radio)
- Radio boiler module DIEMATIC iSystem (transmitter/receiver)
- Simplified remote control with room sensor

- Room sensor
- BUS connection cable (length 12 m)
- Sensor for storage tank
- Radio outside temperature sensor
- Boiler radio module (radio transmitter)
- DIEMATIC VM iSystem control unit

iniControl panel options

- Domestic hot water sensor
- Outlet sensor

Boiler options

- Hydraulic connection kit + gas valve
- Insulation for boiler hydraulic connection kit
- Rear insulation for boiler hydraulic connection kit
- Right gas tap 3/4"
- Pipe cover
- Flue gas thermostat
- 3-stage heating pump
- Modulating electronic heating pump of class A for MCA 45
- Primary pump
- Motorized 3-way valve (Rp 1)
- DHW/boiler connecting kit
- 60/60 - 1" or 80/80 - 1 1/4" decoupling cylinder
- Condensates neutralisation tank
- Condensates neutralisation system with pump
- Wall bracket for neutralisation tank
- Granule refill for neutralisation tank
- Cleaning tool boiler body

DE DIETRICH THERMIQUE
S.A.S. with corporate capital of 22 487 610 €
57, rue de la Gare - F - 67580 Mertzwiller
Tel. +33 3 88 80 27 00 - Fax +33 3 88 80 27 99
www.dedietrich-heating.com

De Dietrich 

